



T-1 3/4 (5mm) Solid State LED Lamps

LTL-307R/307RE Red

LTL-307P/307PE Bright Red

LTL-307E/307EE High Efficiency Red

LTL-307G/307GE Green

LTL-307Y/307YE Yellow

Features

- High intensity.
- Popular T-1 3/4 Diameter package.
- Selected minimum intensities.
- Wide viewing angle.
- General purpose leads.
- Reliable and rugged.

Description

The Red source color devices are made with Gallium Arsenide Phosphide on Gallium Arsenide Red Light Emitting Diode.

The Bright Red source color devices are made with Gallium Phosphide on Gallium Phosphide Red Light Emitting Diode.

The High Efficiency Red and Orange source color devices are made with Gallium Arsenide Phosphide on Gallium Phosphide Orange Light Emitting Diode.

The Green source color devices are made with Gallium Phosphide on Gallium Phosphide Green Light Emitting Diode.

The Yellow source color devices are made with Gallium Arsenide Phosphide on Gallium Phosphide Yellow Light Emitting Diode.

Package Dimensions

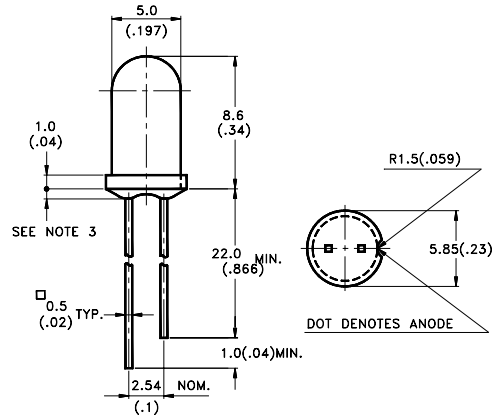

Notes:

1. All dimensions are in millimeters (inches).
2. Tolerance is $\pm 0.25\text{mm}$ (.010") unless otherwise noted.
3. Protruded resin under flange is 1.5mm (.059") max.
4. Lead spacing is measured where the leads emerge from the package.
5. Specifications are subject to change without notice.

Devices

Part No. LTL-	Lens	Source Color
307R	Red Diffused	Red
307RE	Red Transparent	
307P	Red Diffused	Bright Red
307PE	Red Transparent	
307E	Red Diffused	Hi. Eff. Red
307EE	Red Transparent	
307G	Green Diffused	Green
307GE	Green Transparent	
307Y	Yellow Diffused	Yellow
307YE	Yellow Transparent	

Absolute Maximum Ratings at Ta=25°C

Parameter	Red	Bright Red	Green	Yellow	Hi. Eff. Red	Unit
Power Dissipation	80	40	100	60	100	mW
Peak Forward Current (1/10 Duty Cycle, 0.1ms Pulse Width)	200	60	120	80	120	mA
Continuous Forward Current	40	15	30	20	30	mA
Derating Linear From 50°C	0.5	0.2	0.4	0.25	0.4	mA/°C
Reverse Voltage	5	5	5	5	5	V
Operating Temperature Range	-55°C to +100°C					
Storage Temperature Range	-55°C to +100°C					
Lead Soldering Temperature [1.6mm (.063 in.) from body]	260°C for 5 Seconds					

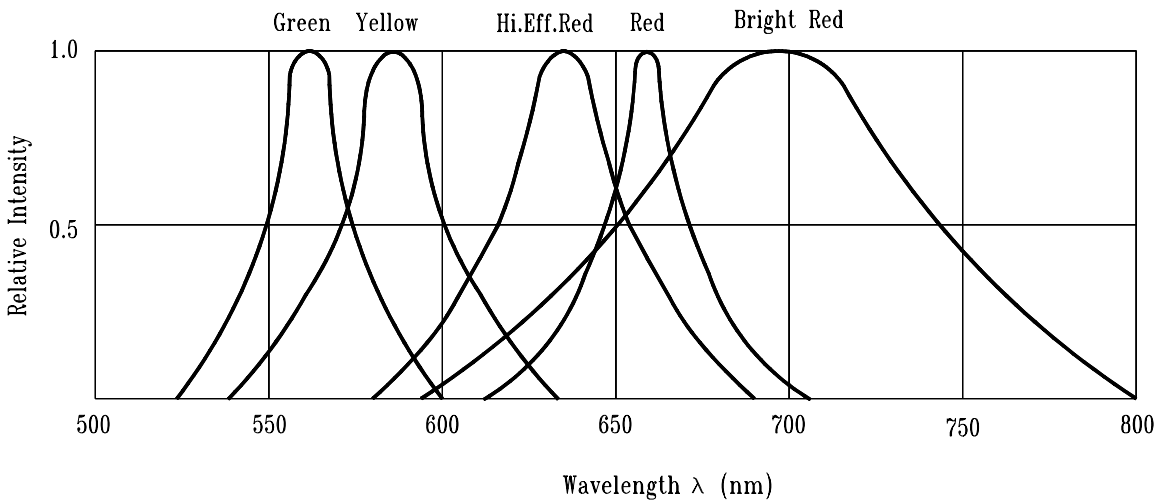

Fig.1 Relative Intensity vs. Wavelength

Electrical/Optical Characteristics at Ta=25°C

Parameter	Symbol	Part No. LTL-	Min.	Typ.	Max.	Unit.	Test Condition.
Luminous Intensity	I _v	307R	0.5	1.7		mcd	I _F =10 mA Note 1,4
		307P	1.7	5.6			
		307E	2.5	8.7			
		307G	5.6	19			
		307Y	8.7	29			
Viewing Angle	2 θ ^{1/2}	307x		50		deg	Note 2 (Fig.7)
Peak Emission Wavelength	λ _P	307R		655		nm	Measurement @Peak (Fig.1)
		307P		697			
		307E		635			
		307G		565			
		307Y		585			
Dominant Wavelength	λ _d	307R		651		nm	Note 3
		307P		657			
		307E		623			
		307G		569			
		307Y		588			
Spectral Line Half Width	Δλ	307R		24		nm	
		307P		90			
		307E		40			
		307G		30			
		307Y		35			
Forward Voltage	V _F	307R		1.7	2.0	V	I _F =20mA
		307P		2.1	2.6		
		307E		2.0	2.6		
		307G		2.1	2.6		
		307Y		2.1	2.6		
Reverse Current	I _R	307x			100	μA	V _R =5V
Capacitance	C	307R		30		pF	V _F =0, f=1MHz
		307P		55			
		307E		20			
		307G		35			
		307Y		15			

- Notes:1.Luminous intensity is measured with a light sensor and filter combination that approximates the CIE eye-response curve.
2.θ^{1/2} is the off-axis angle at which the luminous intensity is half the axial luminous intensity.
3.The dominant wavelength, λ_d is derived from the CIE chromaticity diagram and represents the single wavelength which defines the color of the device.
4.I_v needs ± 15% additionaly for guaranteed limits.

Electrical/Optical Characteristics at Ta=25°C

Parameter	Symbol	Part No. LTL-	Min.	Typ.	Max.	Unit.	Test Condition.
Luminous Intensity	I _v	307RE	1.1	3.7		mcd	I _F =10 mA Note 1,4
		307PE	2.5	8.7			
		307EE	29	90			
		307GE	19	60			
		307YE	12.6	40			
Viewing Angle	2 θ ^{1/2}	307xE		40		deg	Note 2 (Fig.15)
Peak Emission Wavelength	λ _P	307RE		655		nm	Measurement @Peak (Fig.1)
		307PE		697			
		307EE		635			
		307GE		565			
		307YE		585			
Dominant Wavelength	λ _d	307RE		651		nm	Note 3
		307PE		657			
		307EE		623			
		307GE		569			
		307YE		588			
Spectral Line Half Width	Δλ	307RE		24		nm	
		307PE		90			
		307EE		40			
		307GE		30			
		307YE		35			
Forward Voltage	V _F	307RE		1.7	2.0	V	I _F =20mA
		307PE		2.1	2.6		
		307EE		2.0	2.6		
		307GE		2.1	2.6		
		307YE		2.1	2.6		
Reverse Current	I _R	307xE			100	μ A	V _R =5V
Capacitance	C	307RE		30		pF	V _F =0 , f=1MHz
		307PE		55			
		307EE		20			
		307GE		35			
		307YE		15			

Notes:1.Luminous intensity is measured with a light sensor and filter combination that approximates the CIE eye-response curve.

2. θ^{1/2} is the off-axis angle at which the luminous intensity is half the axial luminous intensity.

3.The dominant wavelength, λ_d is derived from the CIE chromaticity diagram and represents the single wavelength which defines the color of the device.

4.I_v needs ± 15% additionaly for guaranteed limits.

Typical Electrical/Optical Characteristic Curves (25°C Ambient Temperature Unless Otherwise Noted)

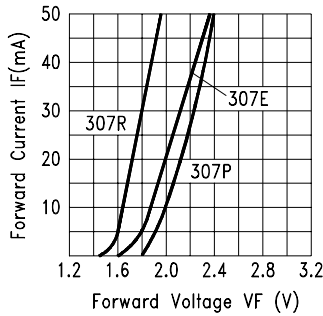

Fig.2 FORWARD CURRENT VS. FORWARD VOLTAGE

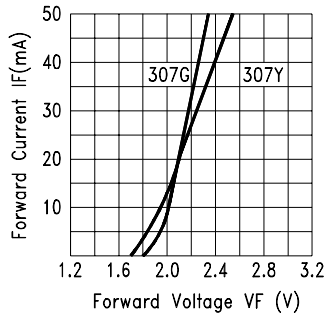

Fig.3 FORWARD CURRENT VS. FORWARD VOLTAGE

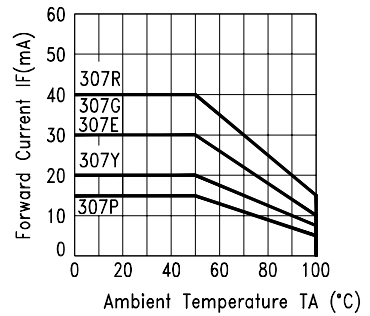

Fig.4 FORWARD CURRENT DERATING CURVE

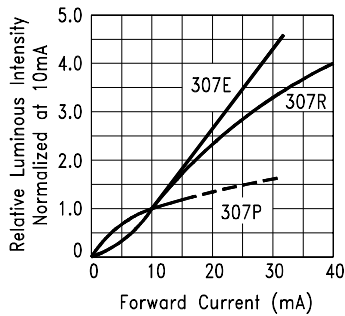

Fig.5 RELATIVE LUMINOUS INTENSITY VS. FORWARD CURRENT

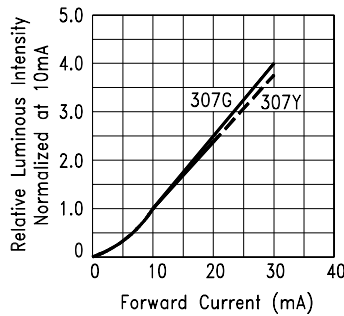

Fig.6 RELATIVE LUMINOUS INTENSITY VS. FORWARD CURRENT

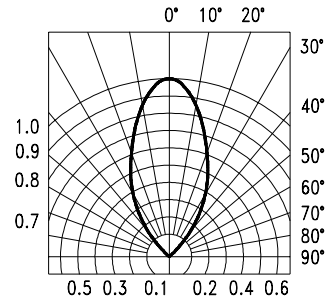

Fig.7 SPATIAL DISTRIBUTION

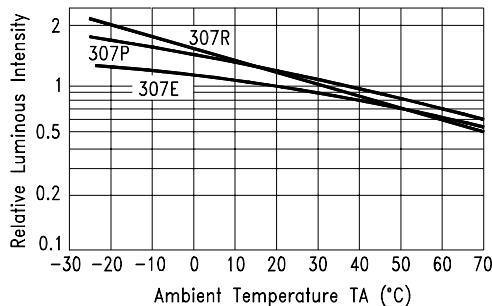

Fig.8 LUMINOUS INTENSITY VS. AMBIENT TEMPERATURE

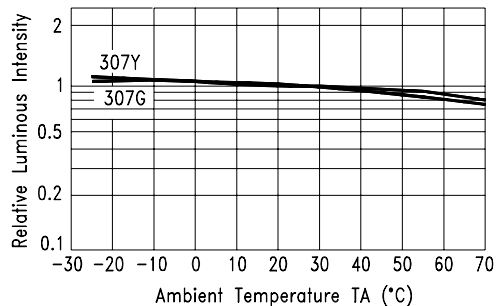

Fig.9 LUMINOUS INTENSITY VS. AMBIENT TEMPERATURE

Typical Electrical/Optical Characteristic Curves (25°C Ambient Temperature Unless Otherwise Noted)

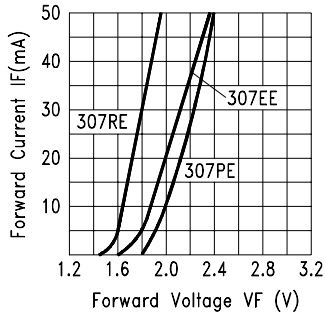

Fig.10 FORWARD CURRENT VS. FORWARD VOLTAGE

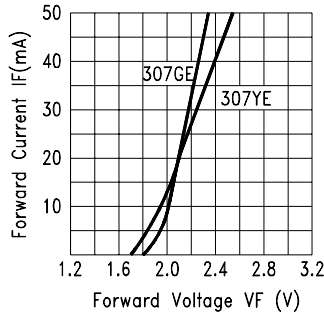

Fig.11 FORWARD CURRENT VS. FORWARD VOLTAGE

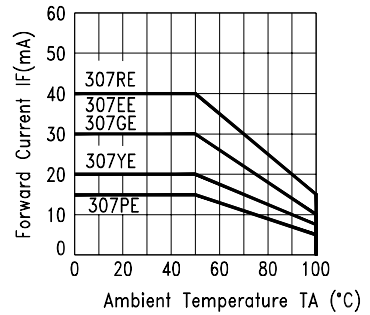

Fig.12 FORWARD CURRENT DERATING CURVE

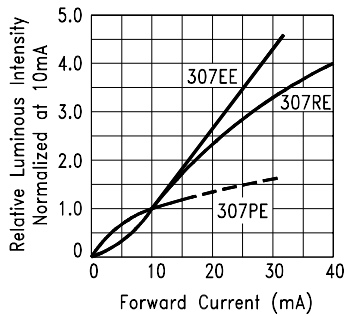

Fig.13 RELATIVE LUMINOUS INTENSITY VS. FORWARD CURRENT

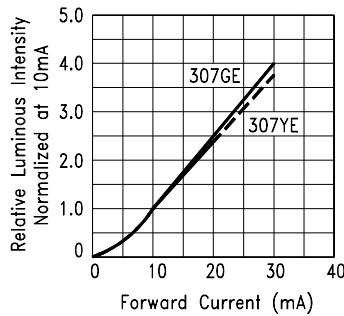

Fig.14 RELATIVE LUMINOUS INTENSITY VS. FORWARD CURRENT

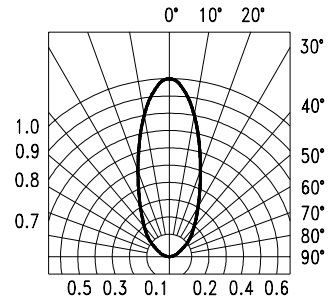

Fig.15 SPATIAL DISTRIBUTION

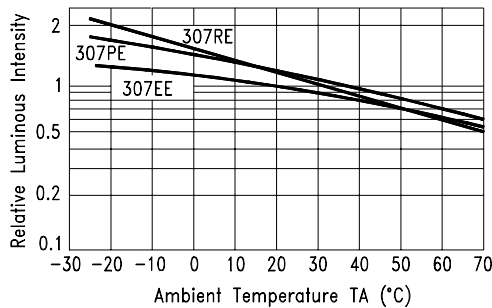

Fig.16 LUMINOUS INTENSITY VS. AMBIENT TEMPERATURE

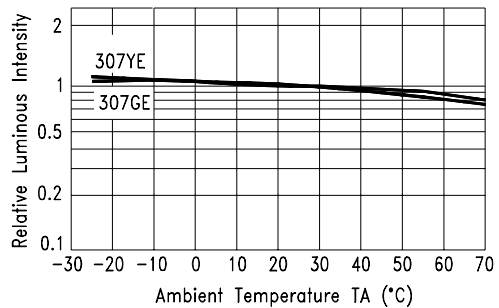

Fig.17 LUMINOUS INTENSITY VS. AMBIENT TEMPERATURE